

REV
SH
1437T
DWG NO

REVISIONS			
REV	DESCRIPTION	DATE	APPROVED

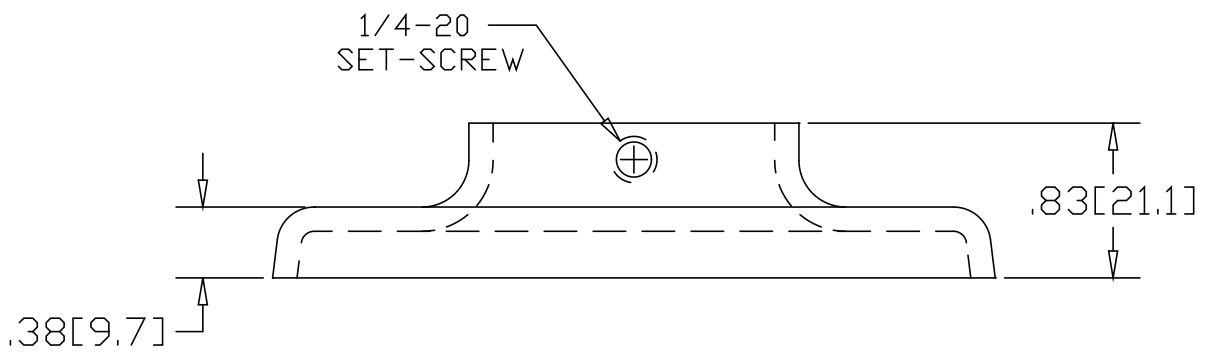
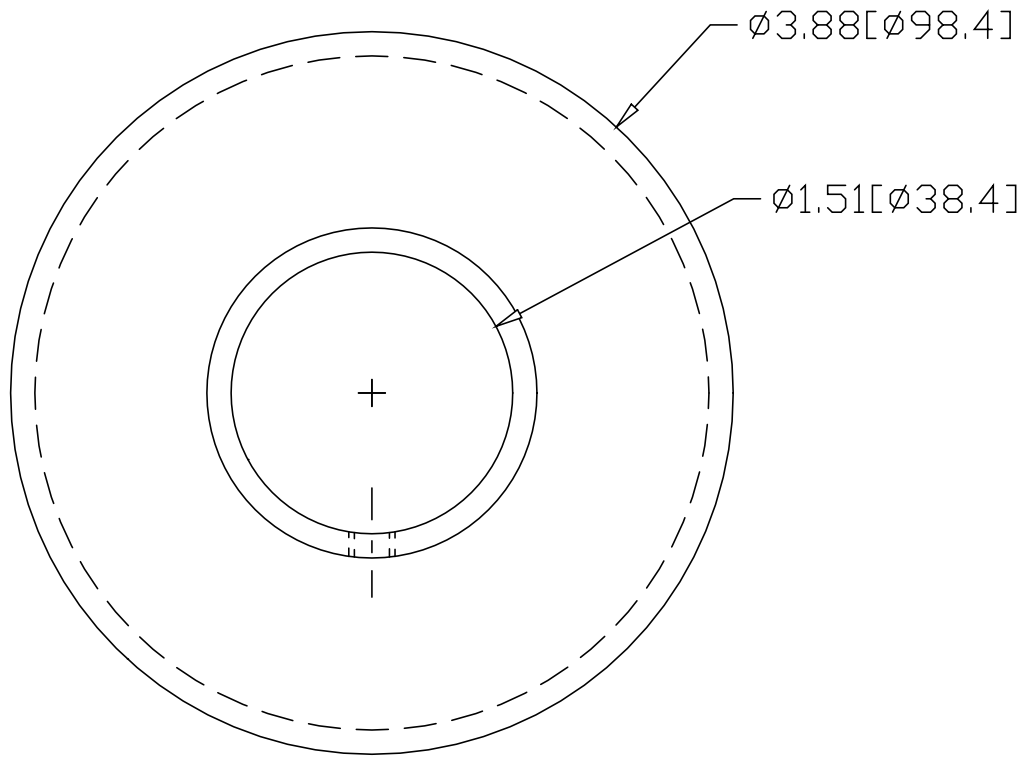

INCHES [MILLIMETERS]

ALTERNATE MATERIAL	PART NUMBER
.125 (3003) ALUMINUM ASTM B209	1477T
10 GA. (304) STAINLESS STEEL ASTM A240	1537T

PART NAME 1.50" OD TUBE HEAVY BASE FLANGE WITH SET-SCREW			
MATERIAL 10 GA. HRP&D STEEL ASTM A569			
DATE 9/13/94	WAGNER	R & B WAGNER, INC.	
DRAWN BY RJF			
FINISH MILL			
SIZE A	WEIGHT .50 LBS	PART NUMBER 1437T	REV