

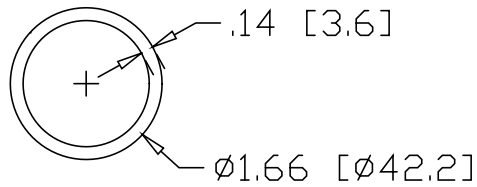

REV
SH
7063
DWG NO

REVISIONS			
REV	DESCRIPTION	DATE	APPROVED

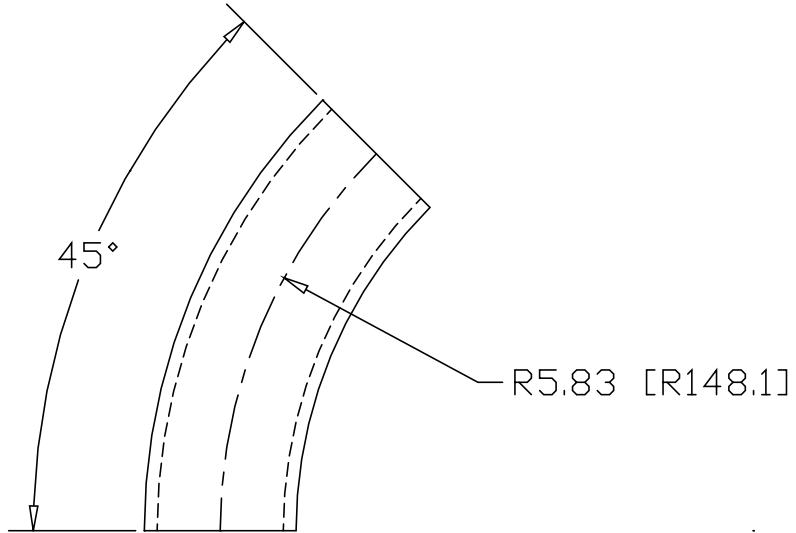

INCHES [MILLIMETERS]

ALTERNATE MATERIAL	PART NUMBER
1-1/4" SCH 40 (6063) ALUMINUM PIPE	7083
1-1/4" SCH 40 (304) STAINLESS STEEL PIPE	7103

PART NAME		1-1/4" PIPE SIZE 45° ELL X 5" I.R.			
MATERIAL		1-1/4" SCH 40 A53 STEEL PIPE			
DATE	7/02/01	 R & B WAGNER, INC.			
DRAWN BY	JAH				
FINISH	MILL	SIZE	WEIGHT	PART NUMBER	REV
		A	.87 LBS	7063	