

REV
SH
DWG NO GR305R.7-R

REVISIONS			
REV	DESCRIPTION	DATE	APPROVED
1	Revised Wagner "W" Logo Notes	7/9/2018	TLK

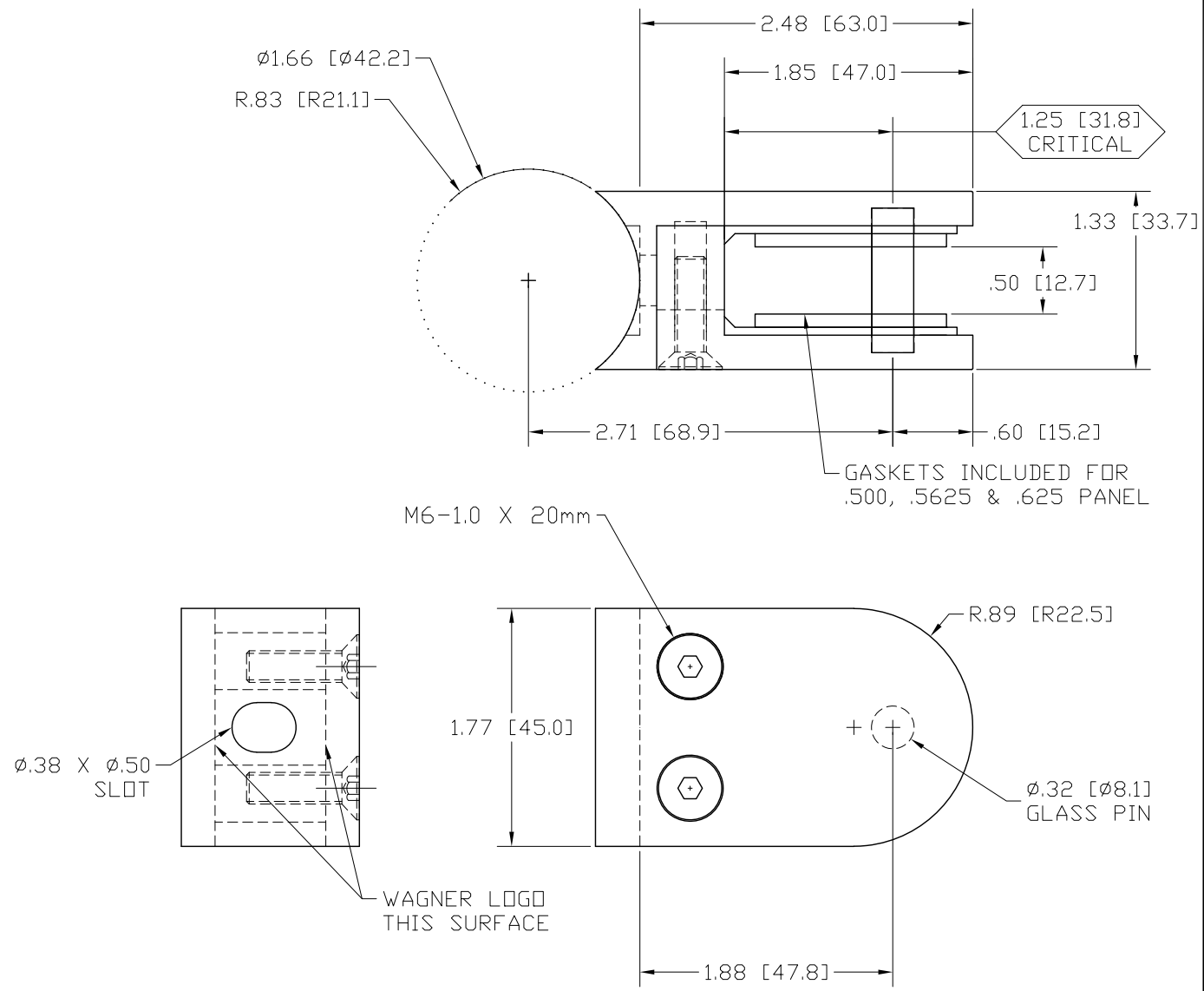

UNLESS OTHERWISE SPECIFIED, DIMENSIONS ON THIS DRAWING ARE SUBJECT TO THE FOLLOWING TOLERANCES:

X.X	=	0.100
X.XX	=	0.030
X.XXX	=	0.010

FOR GLASS THICKNESS 1/2" - 5/8"

PART NAME		GLASS CLIP ASSEMBLY	
MATERIAL		TYPE 316 STAINLESS STEEL	
DATE	01/03/14	 THE WAGNER COMPANIES R & B WAGNER, INC. AND J. G. BRAUN CO.	PART NUMBER GR305R.7-R
DRAWN BY	TLK		
FINISH	#7 BRIGHT		
SIZE	A	REV	1