

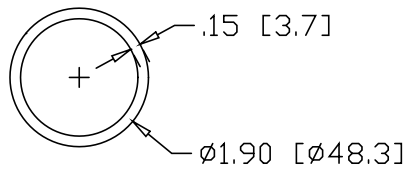

REV  
SH  
7528  
DWG NO

REVISIONS			
REV	DESCRIPTION	DATE	APPROVED

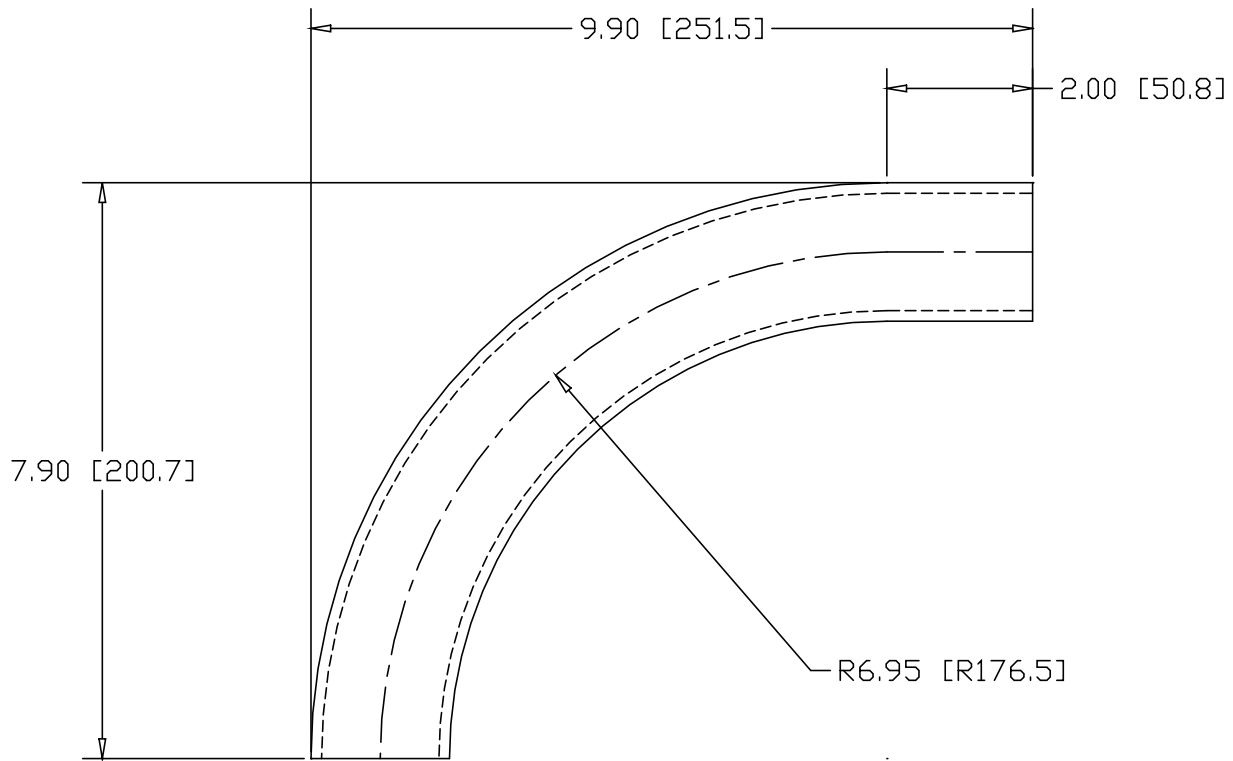

INCHES [MILLIMETERS]

ALTERNATE MATERIAL	PART NUMBER
1-1/2" SCH 40 (6063) ALUMINUM PIPE	7548
1-1/2" SCH 40 (304) STAINLESS STEEL PIPE	7568

PART NAME 1-1/2" PIPE SIZE 90° ELL X 6" I.R. W/ (1) 2" TANGENT			
MATERIAL 1-1/2" SCH 40 A53 STEEL PIPE			
DATE 7/05/01		R & B WAGNER, INC.	
DRAWN BY JAH		SIZE A	WEIGHT 2.93 LBS
FINISH MILL		PART NUMBER 7528	REV