

REV
SH
7069
DWG NO

REVISIONS			
REV	DESCRIPTION	DATE	APPROVED

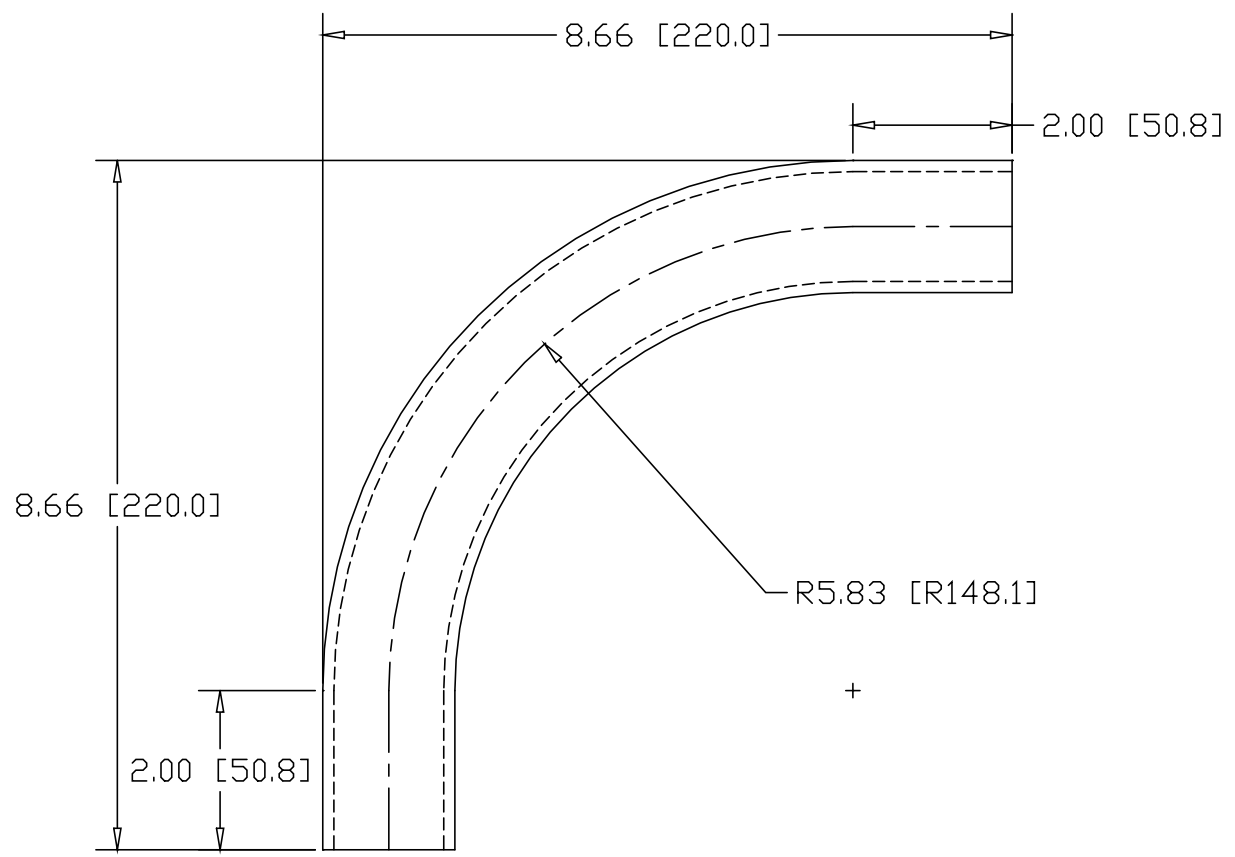

INCHES [MILLIMETERS]

ALTERNATE MATERIAL	PART NUMBER
1-1/4" SCH 40 (6063) ALUMINUM PIPE	7090
1-1/4" SCH 40 (304) STAINLESS STEEL PIPE	7109

PART NAME 1-1/4" PIPE SIZE 90° ELL X 5" I.R. W/ (2) 2" TANGENTS			
MATERIAL 1-1/4" SCH 40 A53 STEEL PIPE			
DATE 7/02/01	WAGNER R & B WAGNER, INC.		
DRAWN BY JAH			
FINISH MILL			
SIZE A	WEIGHT 2.48 LBS	PART NUMBER 7069	REV