

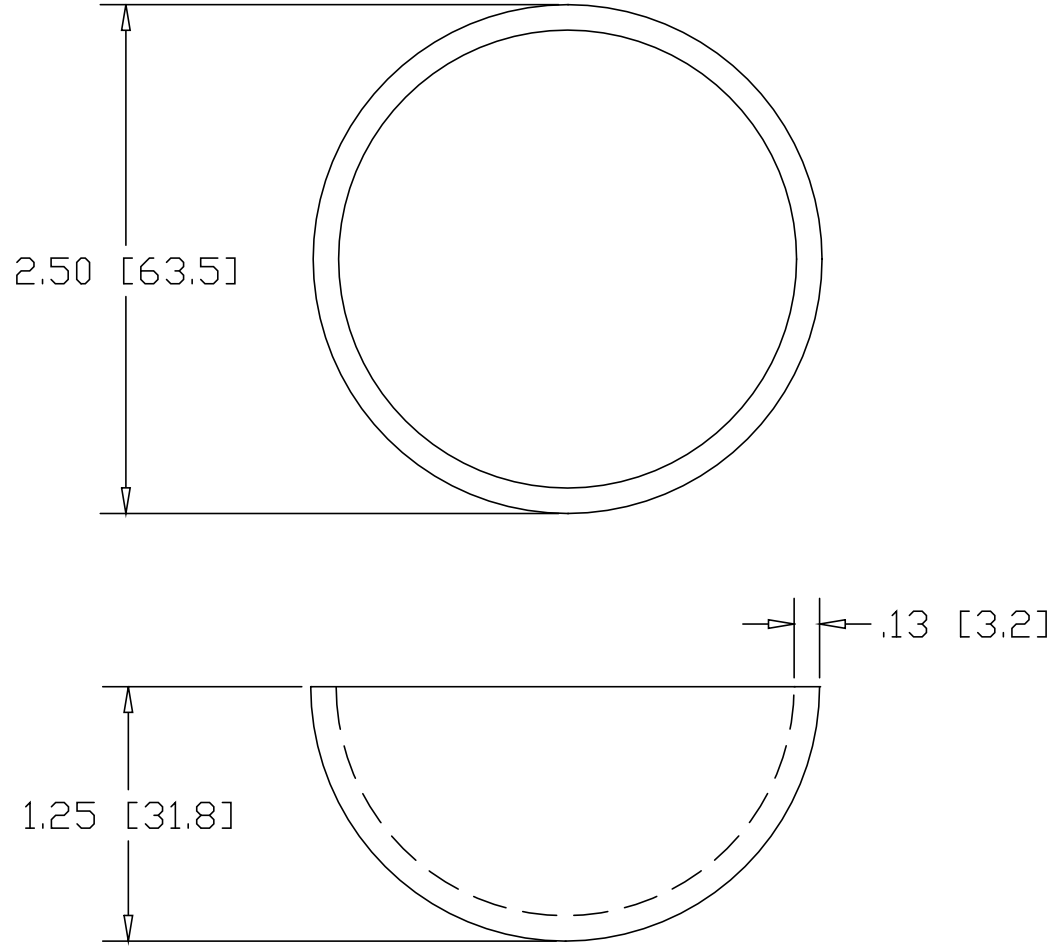

REV  
SH  
DWG NO B4120

REVISIONS			
REV	DESCRIPTION	DATE	APPROVED



INCHES [MILLIMETERS]

ALTERNATE MATERIAL	PART NUMBER
.125 (3003) ALUMINUM SHEET ASTM B209	B4122
11 GA. (.1200) 304 STAINLESS STEEL A240	B4124
.125 (260) BRASS	B4126
.125 (655) SILICON BRONZE	BSB4120

PART NAME		2.50" HEMISPHERE		
MATERIAL		11 GA. (.1196) HRP&D STEEL SHEET ASTM A569		
DATE	1/4/00	 <b>THE WAGNER COMPANIES</b> R & B WAGNER, INC. AND J. G. BRAUN CO.		
DRAWN BY	RJF			
FINISH	MILL			
SIZE	WEIGHT	PART NUMBER	REV	
A	.26 LBS	B4120		