

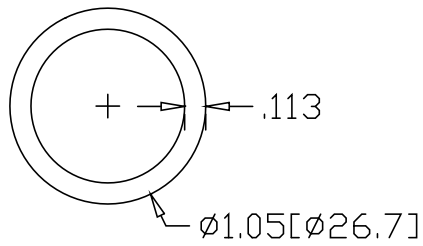

REV
SH
DWG NO 154-1

REVISIONS			
REV	DESCRIPTION	DATE	APPROVED

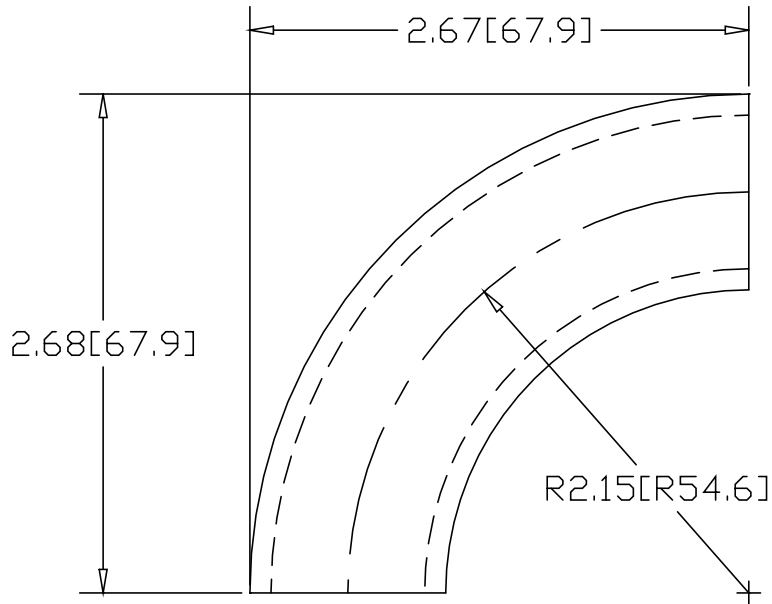

INCHES [MILLIMETERS]

ALTERNATE MATERIAL	PART NUMBER
3/4" SCH 40 (6063) ALUMINUM PIPE	164-1
3/4" SCH 40 (304) STAINLESS STEEL PIPE	174-1

PART NAME		3/4" PIPE SIZE 90° ELL X 1-5/8" I.R.	
MATERIAL		3/4" SCH 40 A53 STEEL PIPE	
DATE	8/18/95	 R & B WAGNER, INC.	
DRAWN BY	RJF		
FINISH	MILL	SIZE	A
		WEIGHT	.30 LBS
		PART NUMBER	154-1
		REV	