

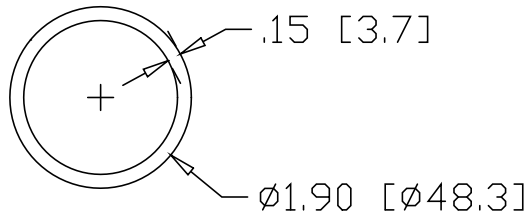

REV
SH
7130
DWG NO

REVISIONS			
REV	DESCRIPTION	DATE	APPROVED

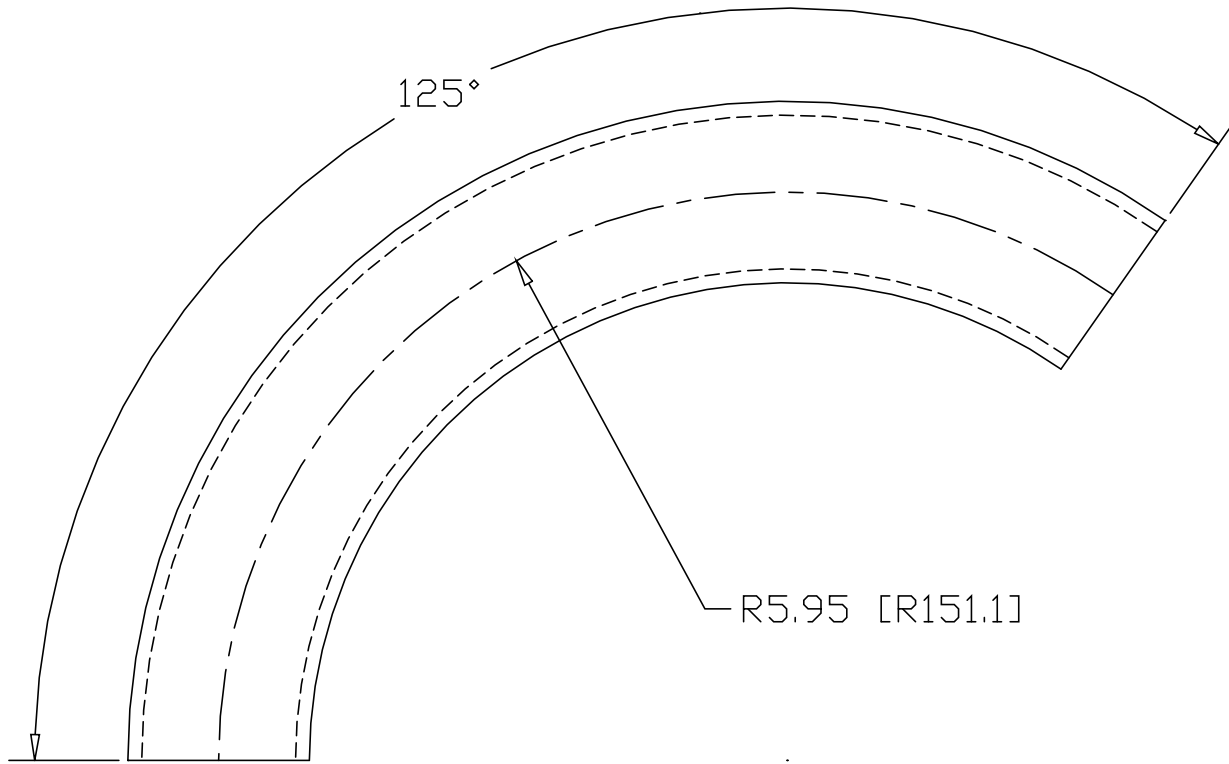

INCHES [MILLIMETERS]

PART NAME		1-1/2" PIPE SIZE 125° ELL X 5" I.R.					
MATERIAL		1-1/2" SCH 40 A53 STEEL PIPE					
DATE	7/03/01		THE WAGNER COMPANIES R & B WAGNER, INC. AND J. G. BRAUN CO.				
DRAWN BY	JAH						
FINISH	MILL						
SIZE	A	WEIGHT	2.94 LBS	PART NUMBER	7130	REV	