

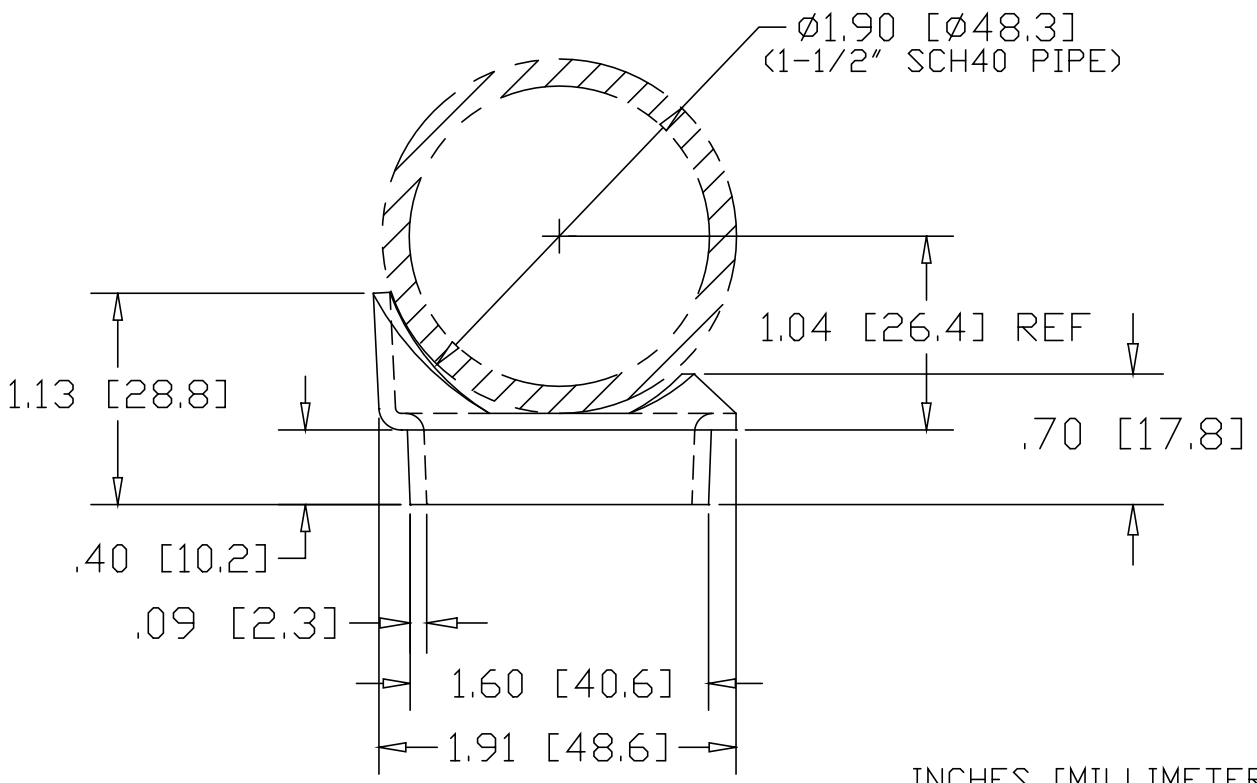

REV
SH
1838
DWG NO

REVISIONS			
REV	DESCRIPTION	DATE	APPROVED

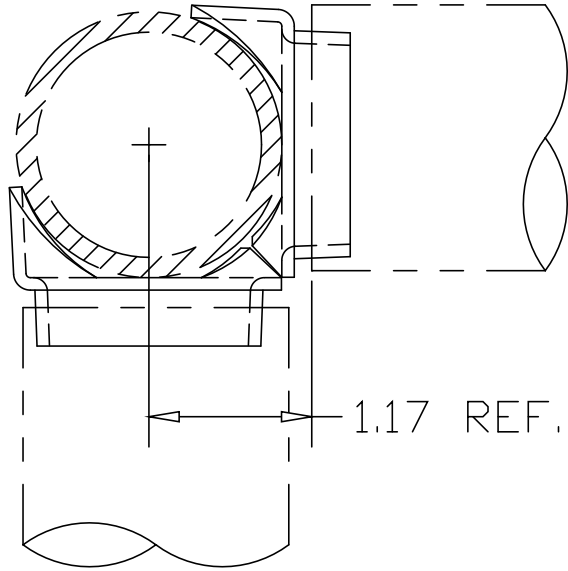
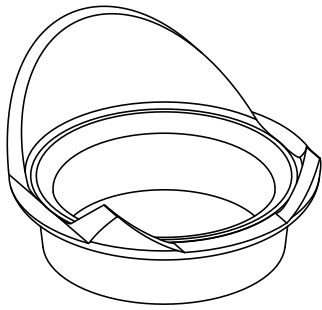

INCHES [MILLIMETERS]

ALTERNATE MATERIAL	PART NUMBER
.09 (3003) ALUMINUM ASTM B209	1839

PART NAME 1-1/2" SCH40 PIPE TYPE "B" COPED WELDING CONNECTOR			
MATERIAL 13 GA. (.089) HRP&D STEEL ASTM A569			
DATE 10/30/01	 R & B WAGNER, INC.		
DRAWN BY JAH			
FINISH MILL	SIZE A	WEIGHT .08 LBS	PART NUMBER 1838
			REV