

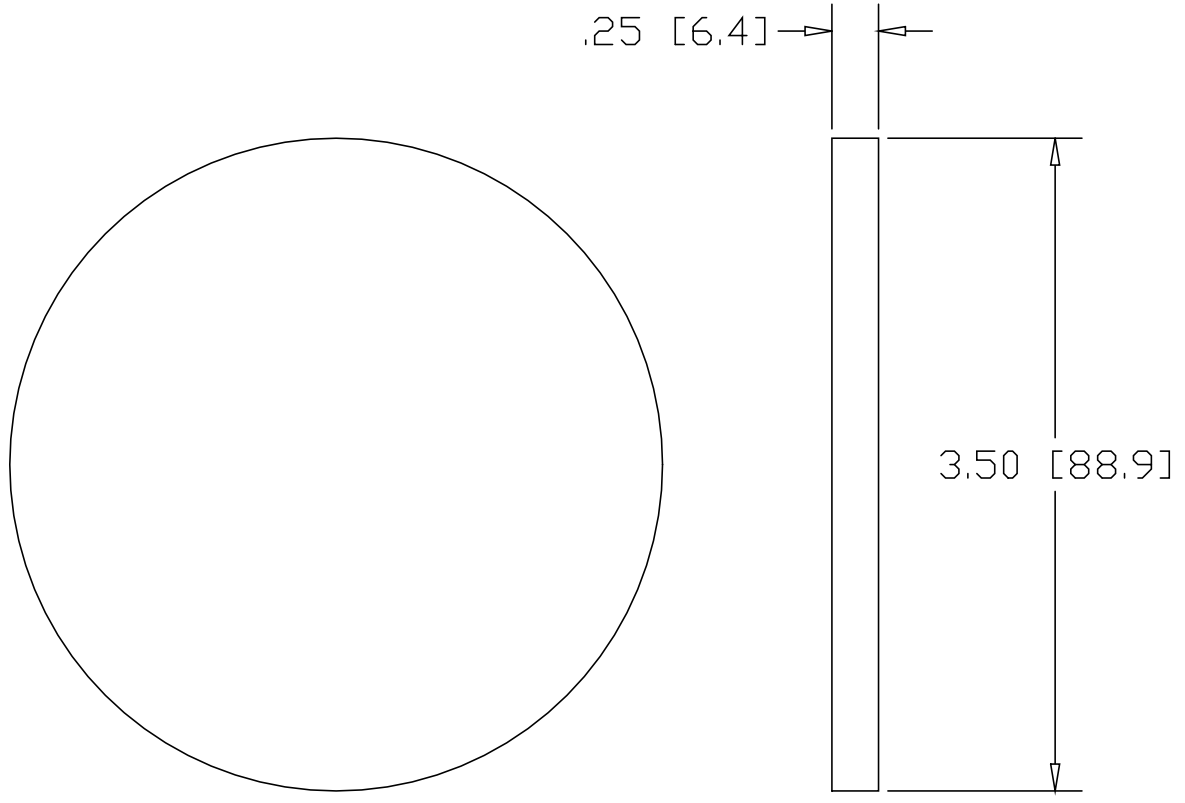

REV
SH
D173
DWG NO

REVISIONS			
REV	DESCRIPTION	DATE	APPROVED



INCHES[MILLIMETERS]

ALTERNATE MATERIAL	PART NUMBER
.250 (3003) ALUMINUM ASTM B209	D174
.250 (304) STAINLESS STEEL ASTM A240	D175
.250 (260) BRASS ASTM B19,B36	D176
.250 (280) MUNTZ METAL	D176M

PART NAME 3.50" OD TUBE SIZE TYPE-D WELD-ON DISK			
MATERIAL .250 HRP&D STEEL ASTM A569			
DATE 11/20/98		THE WAGNER COMPANIES R & B WAGNER, INC. AND J. G. BRAUN CO.	
DRAWN BY RJF			
FINISH MILL			
SIZE A	WEIGHT .7 LBS	PART NUMBER D173	REV