

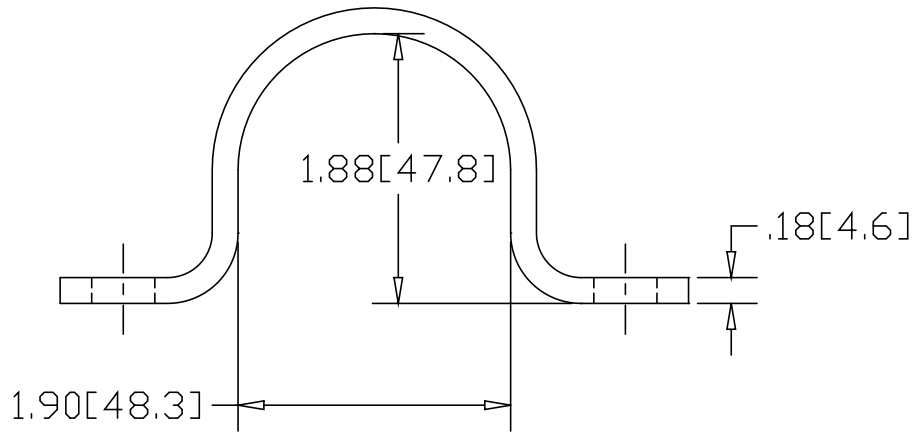

REV  
SH  
3684  
DWG NO

REVISIONS			
REV	DESCRIPTION	DATE	APPROVED

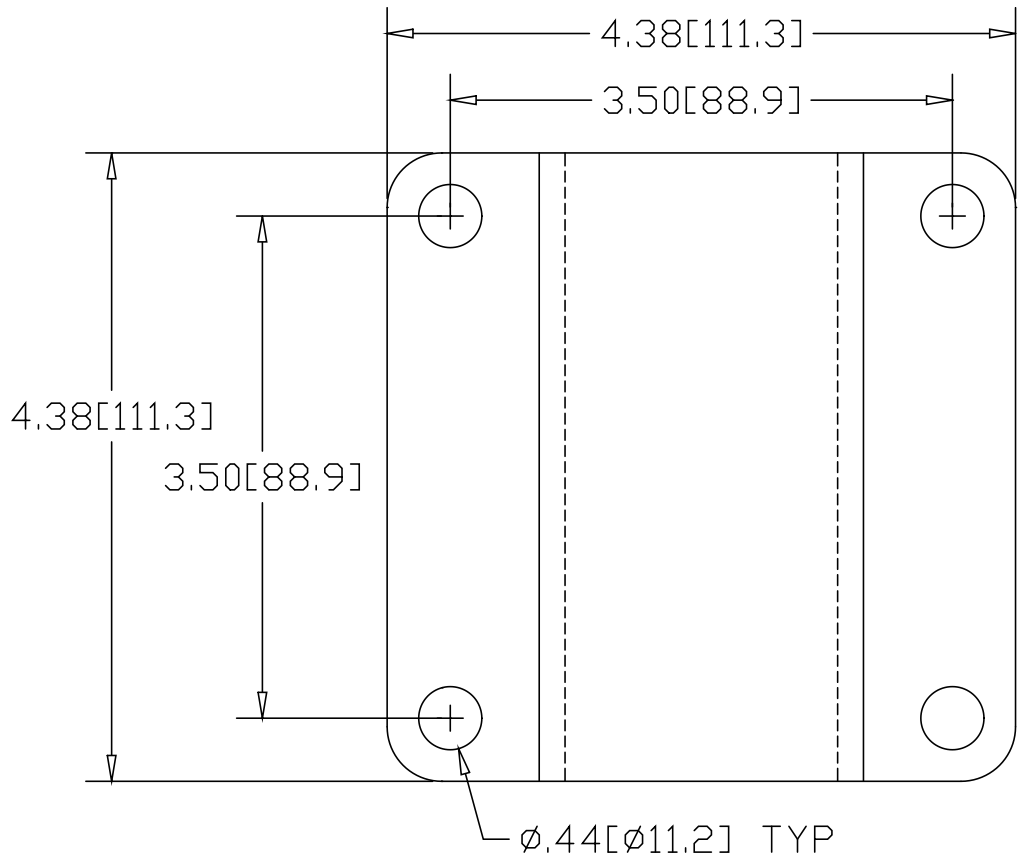

INCHES [MILLIMETERS]

ALTERNATE MATERIAL	PART NUMBER
.190 (3003) ALUMINUM ASTM B209	3685
7 GA. (304) STAINLESS STEEL ASTM A240	3684-SS

PART NAME 1-1/2" PIPE X 4.38" WIDE U-BRACKET W/(4) HOLES			
MATERIAL 7 GA. HRP&D STEEL ASTM A569			
DATE 02/11/00		<b>THE WAGNER COMPANIES</b> R & B WAGNER, INC. AND J. G. BRAUN CO.	
DRAWN BY RJF			
FINISH MILL	SIZE A	WEIGHT 1.41 LBS	PART NUMBER 3684
			REV