

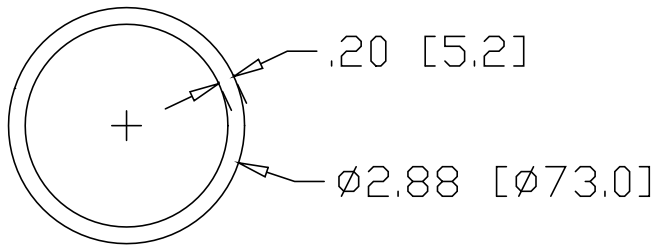

REV
SH
8144
DWG NO

REVISIONS			
REV	DESCRIPTION	DATE	APPROVED

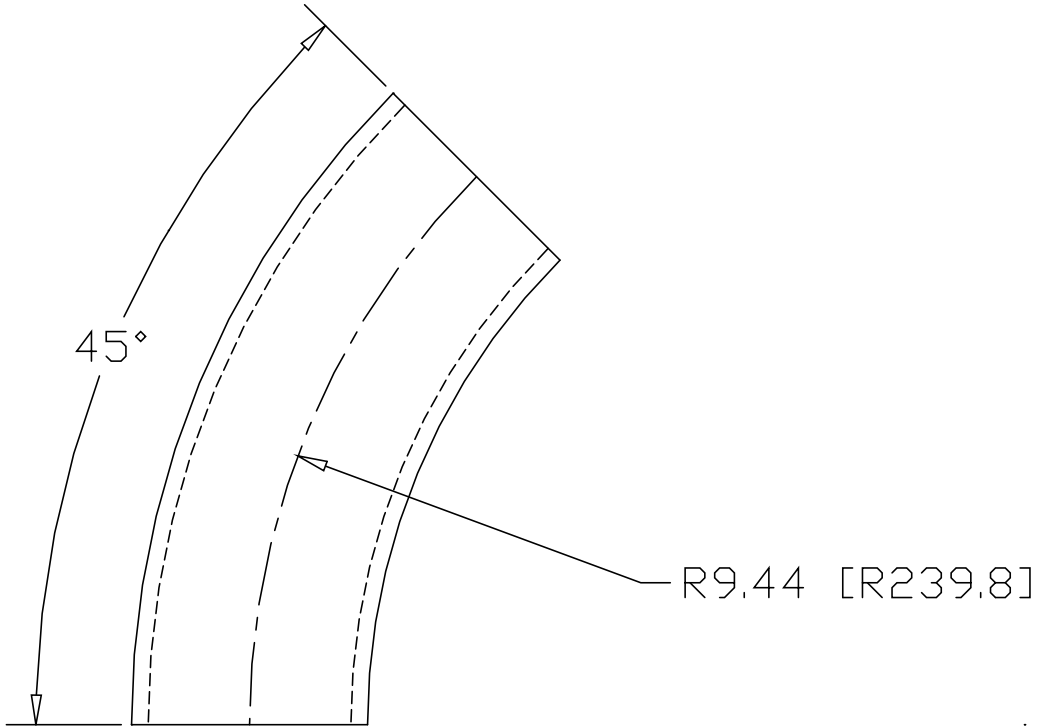

INCHES [MILLIMETERS]

ALTERNATE MATERIAL	PART NUMBER
2-1/2" SCH 40 (6063) ALUMINUM PIPE	8158
2-1/2" SCH 40 (304) STAINLESS STEEL PIPE	8172

PART NAME		2-1/2" PIPE SIZE 45° ELL X 8" I.R.				
MATERIAL		2-1/2" SCH 40 A53 STEEL PIPE				
DATE	7/31/01	 R & B WAGNER, INC.				
DRAWN BY	JAH					
FINISH	MILL					
SIZE	A	WEIGHT	3.56 LBS	PART NUMBER	8144	REV