

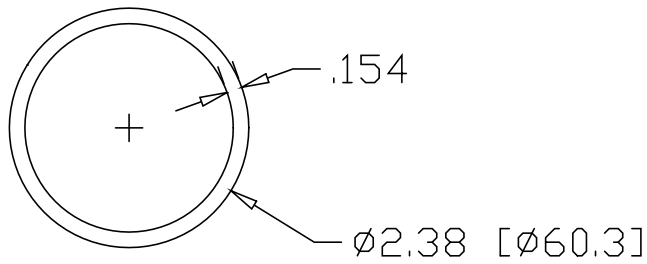

REV
SH
7185
DWG NO

REVISIONS			
REV	DESCRIPTION	DATE	APPROVED

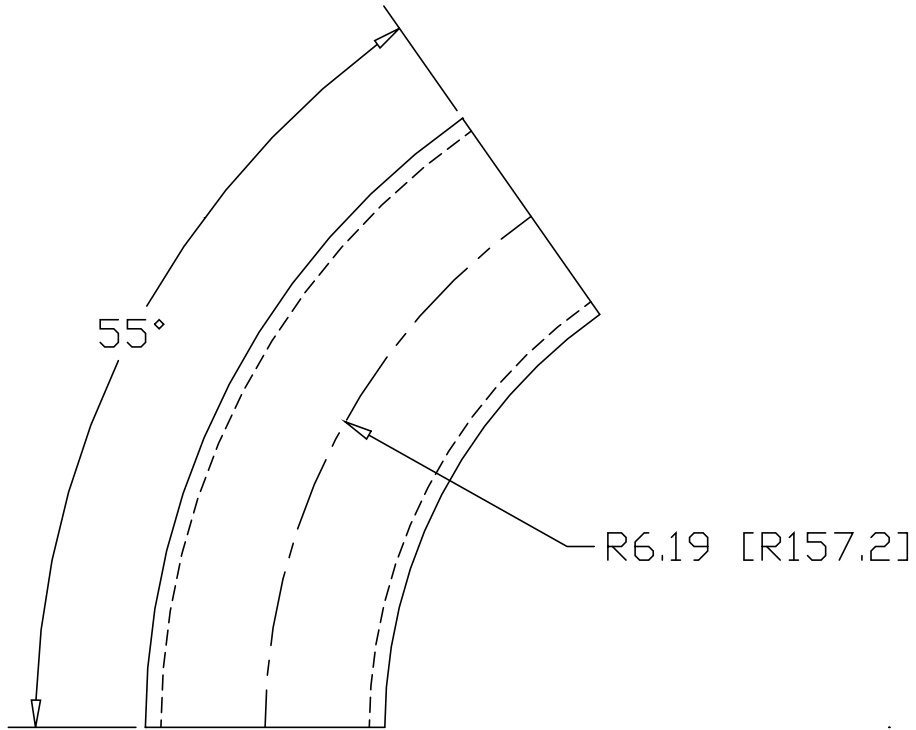

INCHES [MILLIMETERS]

ALTERNATE MATERIAL	PART NUMBER
2" SCH 40 (6063) ALUMINUM PIPE	7205
2" SCH 40 (304) STAINLESS STEEL PIPE	7225

PART NAME		2" PIPE SIZE 55° ELL X 5" I.R.					
MATERIAL		2" SCH 40 A53 STEEL PIPE					
DATE	7/02/01	 R & B WAGNER, INC.					
DRAWN BY	JAH						
FINISH	MILL						
SIZE	A	WEIGHT	1.81 LBS	PART NUMBER	7185	REV	