

REV
SH
5604
DWG NO

REVISIONS			
REV	DESCRIPTION	DATE	APPROVED

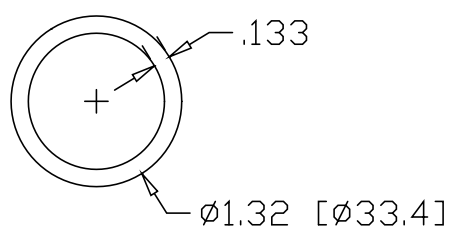
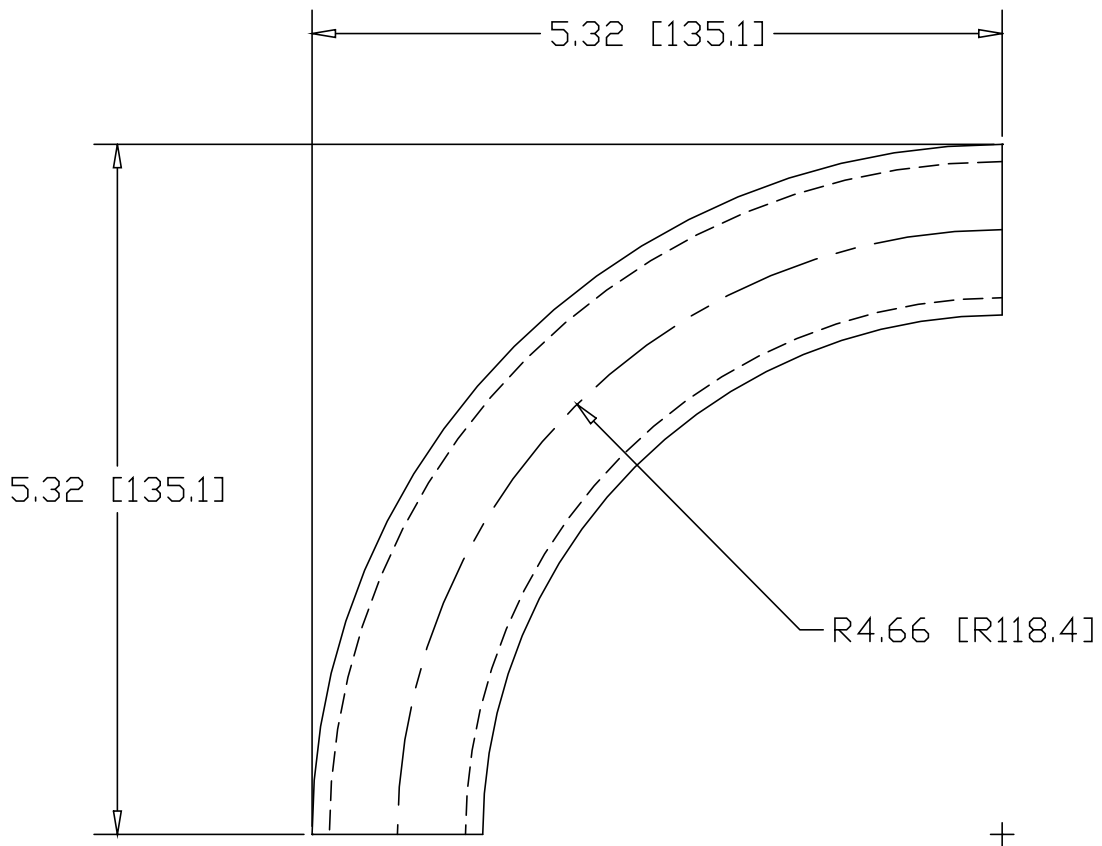

INCHES [MILLIMETERS]

ALTERNATE MATERIAL	PART NUMBER
1" SCH 40 (6063) ALUMINUM PIPE	5614
1" SCH 40 (304) STAINLESS STEEL PIPE	5624

PART NAME		1" PIPE SIZE 90° ELL X 4" I.R.					
MATERIAL		1" SCH 40 A53 STEEL PIPE					
DATE	4/5/96						
DRAWN BY	RJF						
FINISH	MILL						
SIZE	A	WEIGHT	1.02 LBS	PART NUMBER	5604	REV	