

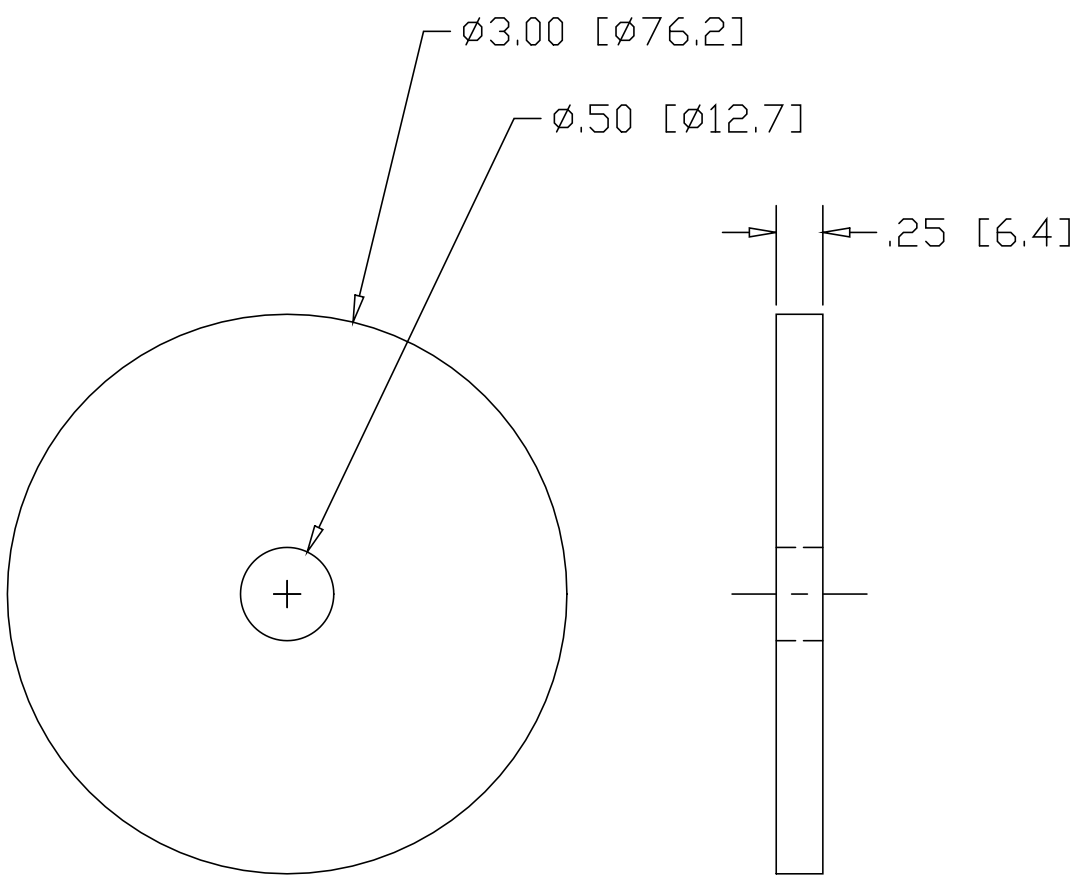

REV
SH
D143C5
DWG NO

REVISIONS			
REV	DESCRIPTION	DATE	APPROVED



INCHES[MILLIMETERS]

ALTERNATE MATERIAL	PART NUMBER
.250 (3003) ALUMINUM ASTM B209	D144C5
.250 (304) STAINLESS STEEL ASTM A240	D145C5
.250 (260) BRASS ASTM B19,B36	D146C5
.250 (280) MUNTZ METAL	D146MC5

PART NAME		3.00" OD BASE DISK WITH .50 DIA CENTER HOLE	
MATERIAL		.250 HRP&D STEEL ASTM A569	
DATE	11/20/98	 THE WAGNER COMPANIES R & B WAGNER, INC. AND J. G. BRAUN CO.	
DRAWN BY	RJF		
FINISH	MILL		
SIZE	A	WEIGHT	.5 LBS
		PART NUMBER	D143C5
		REV	