

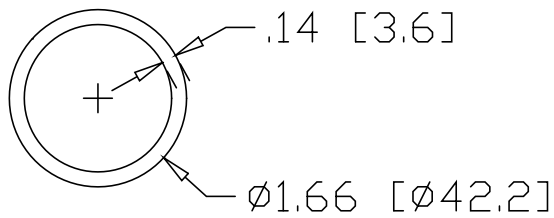

REV
SH
7465
DWG NO

REVISIONS			
REV	DESCRIPTION	DATE	APPROVED

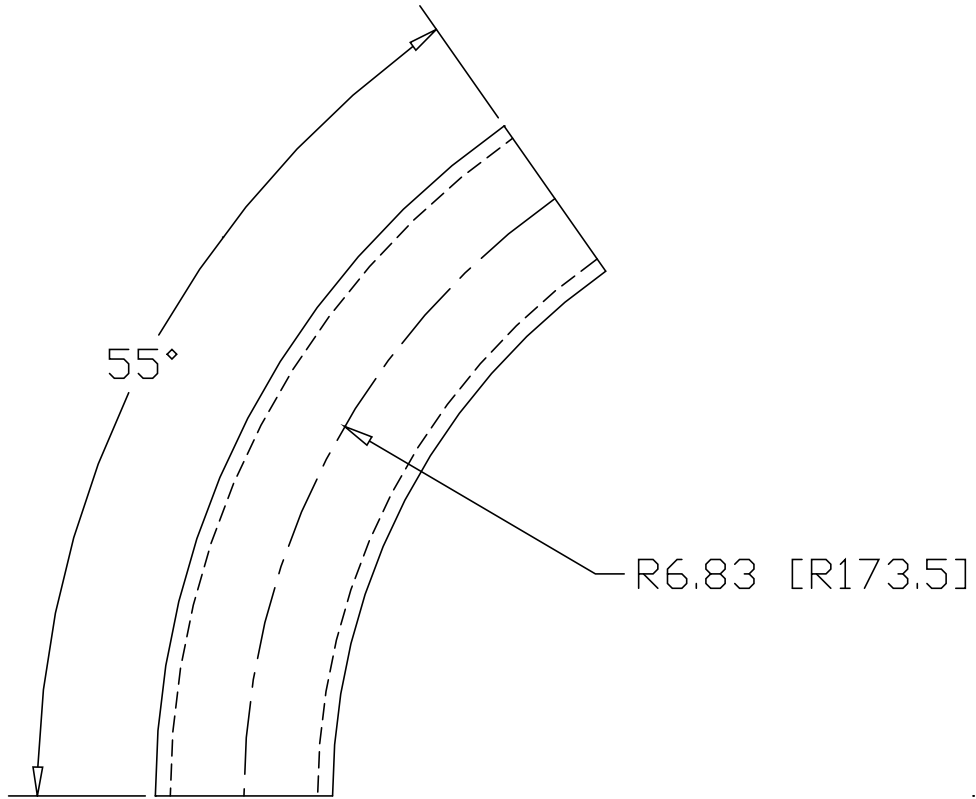

INCHES [MILLIMETERS]

ALTERNATE MATERIAL	PART NUMBER
1-1/4" SCH 40 (6063) ALUMINUM PIPE	7485
1-1/4" SCH 40 (304) STAINLESS STEEL PIPE	7505

PART NAME		1-1/4" PIPE SIZE 55° ELL X 6" I.R.					
MATERIAL		1-1/4" SCH 40 A53 STEEL PIPE					
DATE	7/05/01	 R & B WAGNER, INC.					
DRAWN BY	JAH						
FINISH	MILL						
SIZE	A	WEIGHT	1.24 LBS	PART NUMBER	7465	REV	