

REV
SH
D150
DWG NO

REVISIONS

REV	DESCRIPTION	DATE	APPROVED
-----	-------------	------	----------

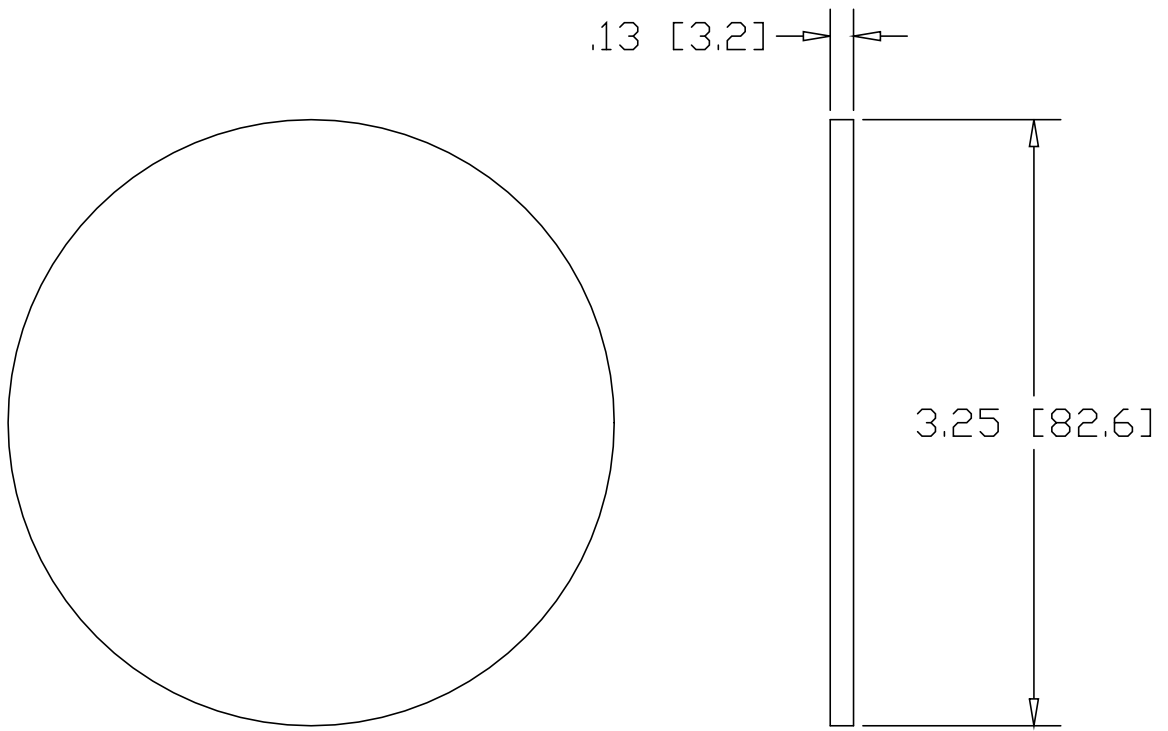

INCHES[MILLIMETERS]

ALTERNATE MATERIAL	PART NUMBER
.125 (3003) ALUMINUM ASTM B209	D151
10 GA. (304) STAINLESS STEEL ASTM A240	D152
.125 (260) BRASS ASTM B19,B36	D153

PART NAME		3.25" OD TUBE SIZE TYPE-D WELD-ON DISK					
MATERIAL		10 GA. HRP&D STEEL ASTM A569					
DATE	11/20/98	 THE WAGNER COMPANIES R & B WAGNER, INC. AND J. G. BRAUN CO.					
DRAWN BY	RJF						
FINISH	MILL						
SIZE	A	WEIGHT	.27 LBS	PART NUMBER	D150	REV	