

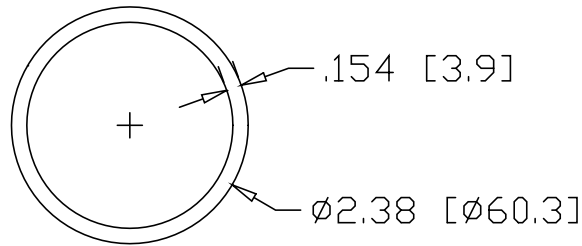

REV  
SH  
5722  
DWG NO

REVISIONS			
REV	DESCRIPTION	DATE	APPROVED

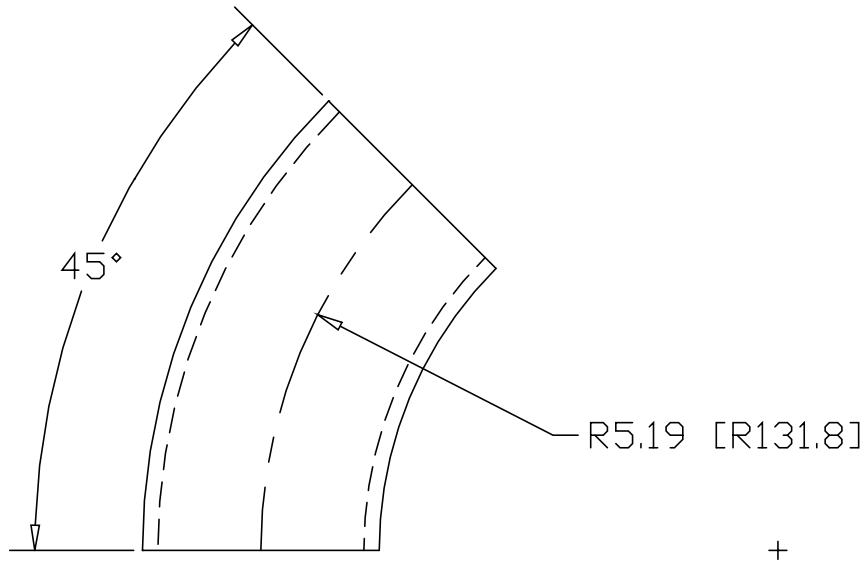

INCHES [MILLIMETERS]

ALTERNATE MATERIAL	PART NUMBER
2" SCH 40 (6063) ALUMINUM PIPE	5736
2" SCH 40 (304) STAINLESS STEEL PIPE	5750

PART NAME				2" PIPE SIZE 45° X 4" I.R. ELL	
MATERIAL				2" SCH 40 STEEL PIPE	
DATE	4/9/96			R & B WAGNER, INC.	
DRAWN BY	RJF				
FINISH	MILL	SIZE	A	WEIGHT	1.23 LBS
			PART NUMBER	5722	REV